

FALCON FAMILY

MOTION SENSOR FOR INDUSTRIAL DOORS , GATES & WARNING INDICATION

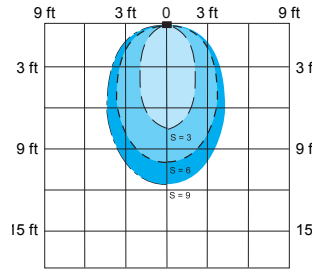

PRIMARY APPLICATIONS



H=11' / Tilt Angle=30

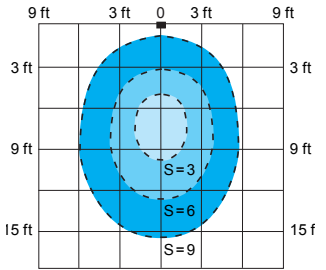

**H = 16' / Tilt Angle = 30
(Standard Falcon Pattern)**

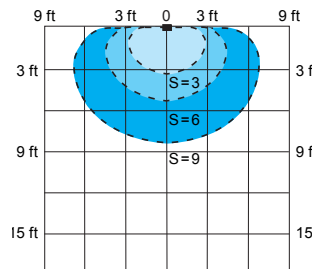

**H = 8' / Tilt Angle = 30
(Falcon XL Pattern)**

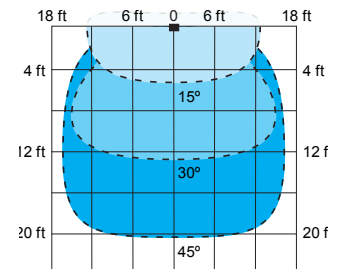

**H = 11.5' / Sensitivity = 9
(Falcon Wide Pattern)**

DESCRIPTION

BEA's Falcon family of sensors is the premier microwave activation solution for indoor and outdoor industrial applications. The family includes the Falcon, Falcon XL (extra low mount) and Falcon Wide (for wide detection areas).

BEA's Falcon family is ideal for automatic industrial doors, vehicle gates/barriers, vehicle detection, loading docks or any other industrial application where motion detection is required.

Housed in a NEMA 4 rated enclosure, the Falcon family is designed to operate in harsh environments.

FEATURES & BENEFITS

- Bidirectional, unidirectional approach and unidirectional depart microwave detection options
- Six modes of detection filtering for pedestrian and parallel traffic rejection
- Falcon family provides three different models with various mounting heights and detection zones (see technical specifications)
- Remote control programming enables user to quickly and safely make changes from the ground
- Tilt angle from 0° – 180°
- NEMA 4 rated enclosure



BEA, Inc.
RIDC Park West
100 Enterprise Drive
Pittsburgh, PA 15275-1213

Customer Service: 800.523.2462
Technical Support: 800.407.4545
www.BEAinc.com

APPLICATIONS

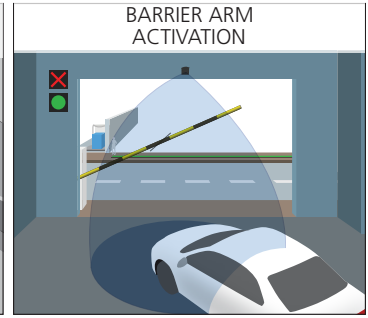
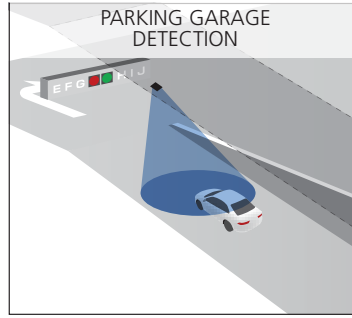
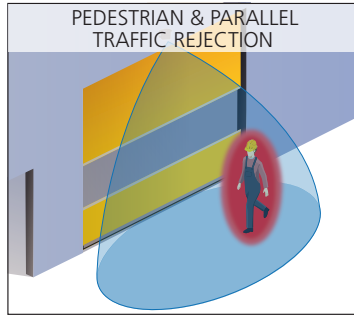
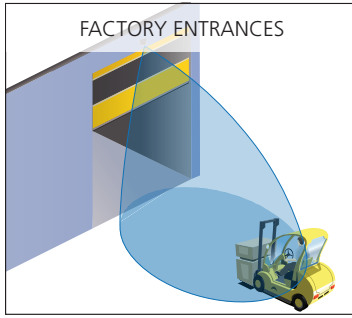

TECHNICAL SPECIFICATIONS

Technology	Microwave Doppler Radar
Radiated Frequency	24.150 GHz
Transmitter Radiated Frequency	< 20 dBm EIRP
Radiated Power Density	< 5 mW / cm ²
Detection Mode	Motion
Detection Zone (WxD)	
Falcon	156 in x 192 in; @ 192 in (13 ft x 16 ft @ 16 ft)
Falcon XL	156 in x 78 in; @ 98.4 in (13 ft x 6.5 ft @ 8.2 ft)
Falcon Wide	360 in x 132 in; @ 252 in (30 ft x 11 ft @ 21 ft) Typical at 30° and field size 9
Tilt Angles	0° – 180°
Output	Relay (free of potential change-over contact)
Max. Contact Voltage	42 VAC / VDC
Max. Contact Current	1 A (resistive)
Max. Switching Power	30 W (DC); 60 VA (AC)
Minimum Detection Speed	2 in / s
LEDs	
Green	Value indication
Red	Detection state & parameter indication
Mains Frequency	50 – 60 Hz
Supply Voltage	12 – 24 VAC; ±10% 12 – 24 VDC; 30% / –10%
Maximum Power Consumption	< 2 W
Mounting Height	
Falcon	138 in – 276 in (11.5 ft – 23 ft)
Falcon XL	78 in – 138 in (6.5 ft – 11.5 ft)
Falcon Wide	138 in – 252 in (11.5 ft – 21 ft)
Dimensions	3.75 in (W) x 4 in (H) x 5 in (D)
Materials	ABS & Polycarbonate
Temperature Range	–22 °F – 140 °F
Degree of Protection	NEMA 4 / IP65
Norm of Conformance	EMC: 2004 / 108 / EC R&TTE: 1999 / 5 / EC

DIMENSIONAL DRAWINGS

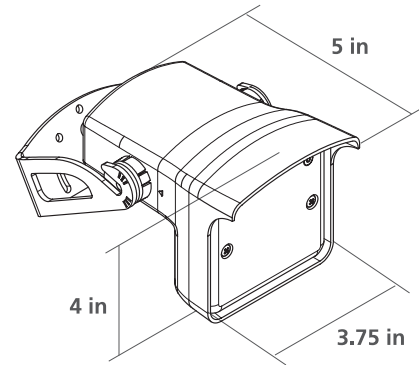

RELATED PRODUCTS



10FALCON
STANDARD
MOUNTING HEIGHTS



10FALCONXL
LOW MOUNTING
HEIGHTS



10FALCONW
WIDE DETECTION
FIELDS



10FALCONEX
EXPLOSION PROOF
MOTION SENSOR SERIES



10INDBRACKET
ADJUSTABLE
MOUNTING BRACKET



10MINIBRACKET
SHORT ADJUSTABLE
MOUNTING BRACKET



10REMOTE
BEA UNIVERSAL
REMOTE CONTROL

www.BEAinc.com

© 2017 BEA, Inc. All rights reserved.

FALCON MOTION SENSOR FOR INDUSTRIAL DOORS, GATES & WARNING INDICATION

BEA, Inc.
RIDC Park West
100 Enterprise Drive
Pittsburgh, PA 15275-1213

Customer Service: 800.523.2462
Technical Support: 800.407.4545

